

REVISION

1	5825
2	6127
3	
4	
5	
6	
7	
8	
9	
10	
11	
12	
13	
14	
15	
16	
17	
18	
19	
20	

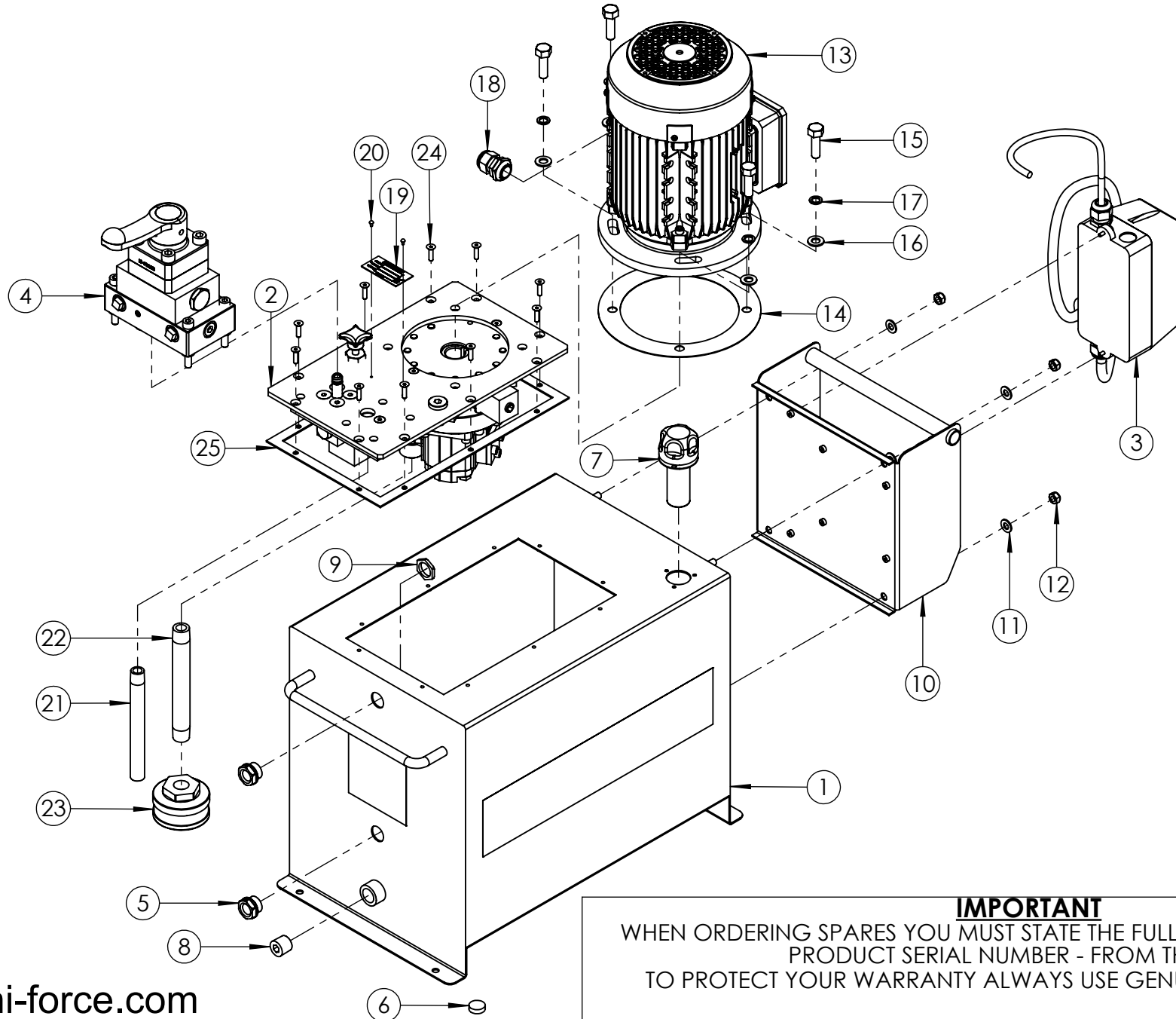

IMPORTANT
WHEN ORDERING SPARES YOU MUST STATE THE FULL PART NUMBER AND THE
PRODUCT SERIAL NUMBER - FROM THE LABEL
TO PROTECT YOUR WARRANTY ALWAYS USE GENUINE HI-FORCE PARTS.

ITEM NO.	PART NUMBER	DESCRIPTION	QTY.	SPARE PARTS	SERVICE PARTS
1	TAC040AS004	40 L TANK	1		
2	TYPE300-24	300 SERIES PUMP UNIT	1		
3	EMA415UD001	400 V MOTOR STARTER ASSEMBLY	1		
4	PMV4L	4 WAY, MANUALLY OPERATED, PUMP MOUNTED DIRECTIONAL CONTROL VALVE WITH LOAD HOLDING	1		
5	BLC021YT010	SIGHT GLASS HGF.13 BLACK OIL LEVEL INDICATOR	2		
6	DCSF00328	DOUBLE SIDED MAGNET	1		
7	FFC028PZ001	FILLER/BREATHER	1		
8	FPC013PC001	1/2" BSP PLUG - HEX SOCKET	1		
9	NUC021-B000	1/2" BSP LOCK NUT	2		
10	TAC000FS002	MODULAR ELECTRIC TRAY	1		
11	WAC008AB000	M8 PLAIN WASHER	4		
12	NUC008KC000	M8 NYLOC NUT	4		
13	EM415-3.0-2LAF	3kW 2 POLE IE3 230/400V 3/50Hz IMB5 FLANGE MOUNT	1		
14	SEC001KT003	GASKET	1		✓
15	BLC010LB035	M10 x 35 mm HEX HEAD BOLT, ZINC PLATED	4		
16	WAC010AB000	M10 ZINC PLATED FLAT WASHER	4		
17	WAC010BZ000	M10 SPRING WASHER	4		
18	NUC020LS002	GLAND 6-12MM	1		
19	AAN000UP001	60 x 30 mm UNIVERSAL NAME PLATE	1	x	
20	FAS002HZ001	NO.4 x 3/16 HAMMER DRIVE SCREW	2		
21	TAC000PA001	160 mm LONG SUCTION PIPE	1		
22	FPC013AC002	FEED PIPE	1		
23	FFC045MZ001	FILTER	1		
24	BLC005HF020	M5 x 20 mm HEX SOCKET COUNTERSUNK SCREW	10		
25	15482	TANK GASKET	1		✓
*	SFC065FA002	BLANKING PLATE	1		

REVISION

1 5825

2 6127

3

4

5

6

7

8

9

10

11

12

13

14

15

16

17

18

19

20

NOTE:

- ALL PARTS ARE AVAILABLE TO BE ORDERED AS SPARE PARTS (UNLESS MARKED WITH x).

- ONLY PARTS MARKED WITH ✓ ARE AVAILABLE AS BOTH SPARE PARTS OR SERVICEABLE PARTS, FROM **HEP-SK1 PUMP SERVICE KIT**. (REFER TO HEP-SK1: PUMP SERVICE KIT EVD FOR FULL PARTS LIST)

- FOR SUB ASSEMBLIES (ITEM NO.S 2, 3 & 4) REFER TO THEIR INDIVIDUAL EVD's.

IMPORTANT

WHEN ORDERING SPARES YOU MUST STATE THE FULL PART NUMBER AND THE PRODUCT SERIAL NUMBER - FROM THE LABEL TO PROTECT YOUR WARRANTY ALWAYS USE GENUINE HI-FORCE PARTS.

ITEM NO.	PART NUMBER	DESCRIPTION	QTY.	SPARE PARTS	SERVICE PARTS
1	TAC000BA003	COVER PLATE	1		
2	PMC000UM001	UPPER PLATE	1		
3	PMC000LF001	LOWER PLATE	1		
4	15503	CONNECTOR PIPE	1		
5	15505	24mm DRIVE SHAFT	1		
6	17587	TRANSFER BLOCK	1		
7	17588	VALVE PLATE	1		
8	BAC008SN000	Ø8 mm STEEL BALL GRADE 100	5		
9	BLC005HF016	M5 x 16 mm HEX SOCKET COUNTERSUNK SCREW	2		
10	BLC006JE016	M6 x 16 mm HEX SOCKET COUNTERSUNK SCREW	1		
11	BLC008KF035	M8 x 35 mm HEX SOCKET COUNTERSUNK SCREW	4		
12	BLC006JC045	M6 x 45 mm HEX SOCKET CAP HEAD SCREW	2		
13	BLC006JD025	M6 x 25 mm HEX SOCKET CAP HEAD SCREW	4		
14	BLC008KC080	M8 x 80 mm HEX SOCKET CAP HEAD SCREW	6		
15	BLC008KC060	M8 x 60 mm HEX SOCKET CAP HEAD SCREW	2		
16	BPC006RS001	SEALING PLUG	4		
17	BSC025MC001	LOWER PLATE BEARING	1		
18	BSC035NC001	UPPER PLATE BEARING	1		
19	BSC040ND001	ECCENTRIC BEARING	1		
20	FAS006GJ010	1/4" BSP HEX HEAD BLANKING PLUG	1		
21	FAS010MA010	M10 X 10 CUP POINT GRUB SCREW	5		
22	FFC012MA001	SUCTION FILTER	1		
23	HPRV1	HIGH PRESSURE R/VALVE	1		
24	LPRV1	LOW PRESSURE R/VALVE	1		
25	SEC013BA001	BACK-UP RING - PTFE, SOLID SPLIT	2		✓
26	SEC013RA001	O-RING - I.D. 9.25mm, C.S. 1.78mm, NITRILE 90	2		✓
27	SEC014RF001	O-RING - I.D. 10.82 mm, C.S. 1.78 mm, NITRILE 90	4		✓

ITEM NO.	PART NUMBER	DESCRIPTION	QTY.	SPARE PARTS	SERVICE PARTS	REVISION
28	SEC035WE001	UPPER PLATE OIL SEAL	1			1 5817
29	STC025AA001	EXTERNAL CIRCLIP - 25 x 1.2 mm D1400/025	1			2 5939
30	STC040AA001	EXTERNAL CIRCLIP - 40 x 1.75 mm D2100/0400	2			3
31	WAC006AF000	M6 ZINC WASHER	4			4
32	WAC006BC001	M6 SPRING ZINC WASHER (SQUARE SECTION)	2			5
33	WAC007HD000	1/4" BSP SELF CENTERING BONDED WASHER	1			6
34	STC047BA001	INTERNAL CIRCLIP - 47 x 1.75 mm D1300/0470	1			7
35	15494-A	PISTON BLOCK ASSEMBLY	3			8
36	FPC010PB001	3/8" BSP BLANKING PLUG	1			9
37	PMA060GZ001	GP60 GEAR PUMP ASSEMBLY	1			10
						11
						12
						13
						14
						15
						16
						17
						18
						19
						20

NOTE:

- ALL PARTS ARE AVAILABLE TO BE ORDERED AS SPARE PARTS (UNLESS MARKED WITH X).

- ONLY PARTS MARKED WITH ✓ ARE AVAILABLE AS BOTH SPARE PARTS OR SERVICEABLE PARTS FROM **HEP-SK1 PUMP SERVICE KIT**. (REFER TO HEP-SK1: PUMP SERVICE KIT EVD FOR FULL PARTS LIST)

- IF ITEM NO. 24 (**LPRV1**) IS ORDERED AS A SPARE PART, THIS ALREADY COMES WITH 2 OFF ITEM NO.27 (**SEC014RF001**). THEREFORE THESE ARE NOT REQUIRED TO BE ORDERED SEPERATELY.

- FOR SUB ASSEMBLIES - ITEM NO. 35 (**15494-A**) & ITEM NO. 37 (**PMA060GZ001**) REFER TO THEIR INDIVIDUAL EVD'S.

IMPORTANT

WHEN ORDERING SPARES YOU MUST STATE THE FULL PART NUMBER AND THE PRODUCT SERIAL NUMBER - FROM THE LABEL TO PROTECT YOUR WARRANTY ALWAYS USE GENUINE HI-FORCE PARTS.

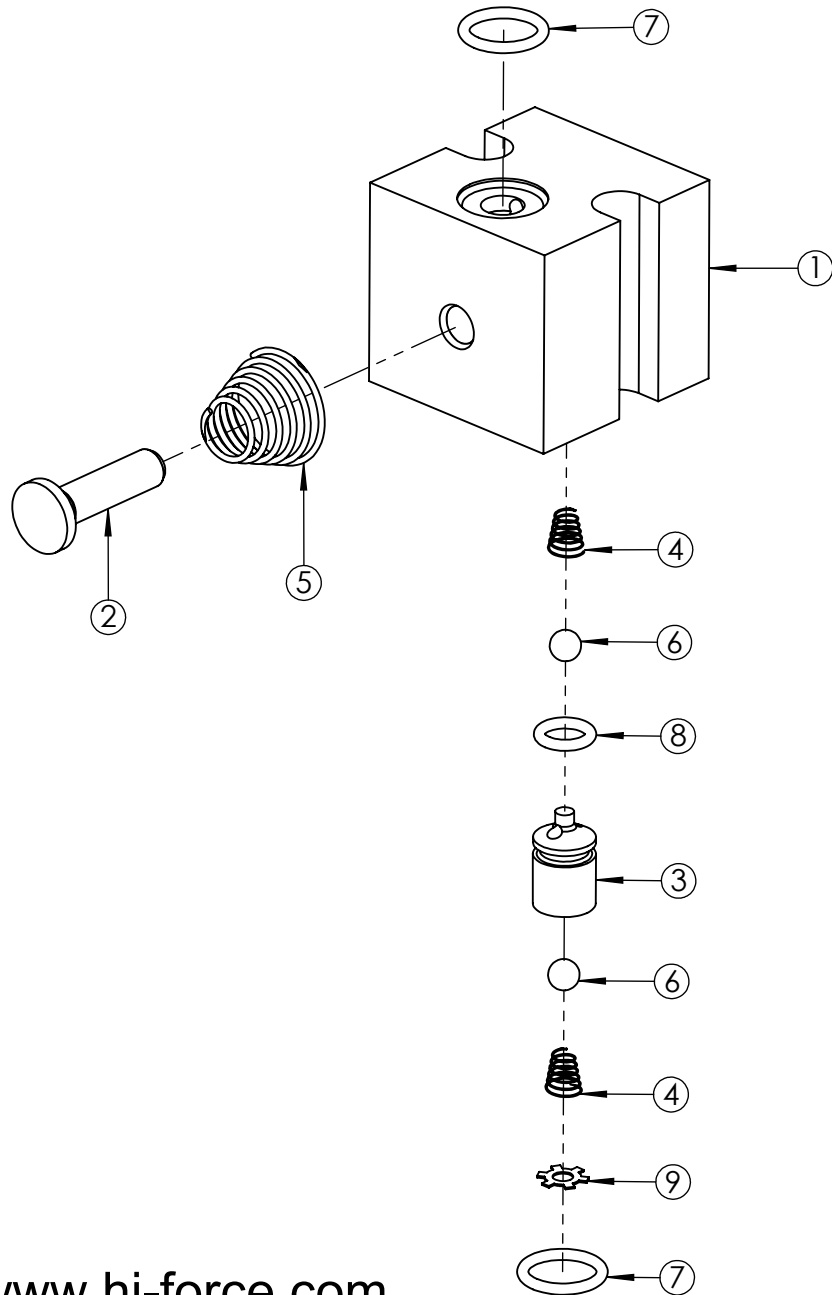

ITEM NO.	PART NUMBER	DESCRIPTION	QTY.	SPARE PARTS	SERVICE PARTS	REVISION
1	15494	PISTON BLOCK	1	X		1 5717
2	15495	PISTON	1	X		2 5866
3	15496	VALVE SEAT	1	X		3
4	15509	SUCTION/DELIVERY SPRING	2	X		4
5	15508	PUMP SPRING	1	X		5
6	BAC005SN000	Ø5 mm STEEL BALL GRADE 100	2	X		6
7	SEC014RF001	O-RING - I.D. 10.82 mm, C.S. 1.78 mm, NITRILE 90	2		✓	7
8	SEC010RA001	O-RING - I.D. 6.35 mm, C.S. 1.78 mm, NITRILE 70	1	X		8
9	STC008SA001	N1305-0031 SELF LOCKING RING	1	X		9
						10
						11
						12
						13
						14
						15
						16
						17
						18
						19
						20

NOTE:

- ALL PARTS ARE AVAILABLE TO BE ORDERED AS SPARE PARTS (UNLESS MARKED WITH X).

- ONLY PARTS MARKED WITH ✓ ARE AVAILABLE AS BOTH SPARE PARTS OR SERVICEABLE PARTS, FROM **HEP-SK1 PUMP SERVICE KIT**. (REFER TO HEP-SK1: PUMP SERVICE KIT EVD FOR FULL PARTS LIST).

IMPORTANT

WHEN ORDERING SPARES YOU MUST STATE THE FULL PART NUMBER AND THE PRODUCT SERIAL NUMBER - FROM THE LABEL TO PROTECT YOUR WARRANTY ALWAYS USE GENUINE HI-FORCE PARTS.

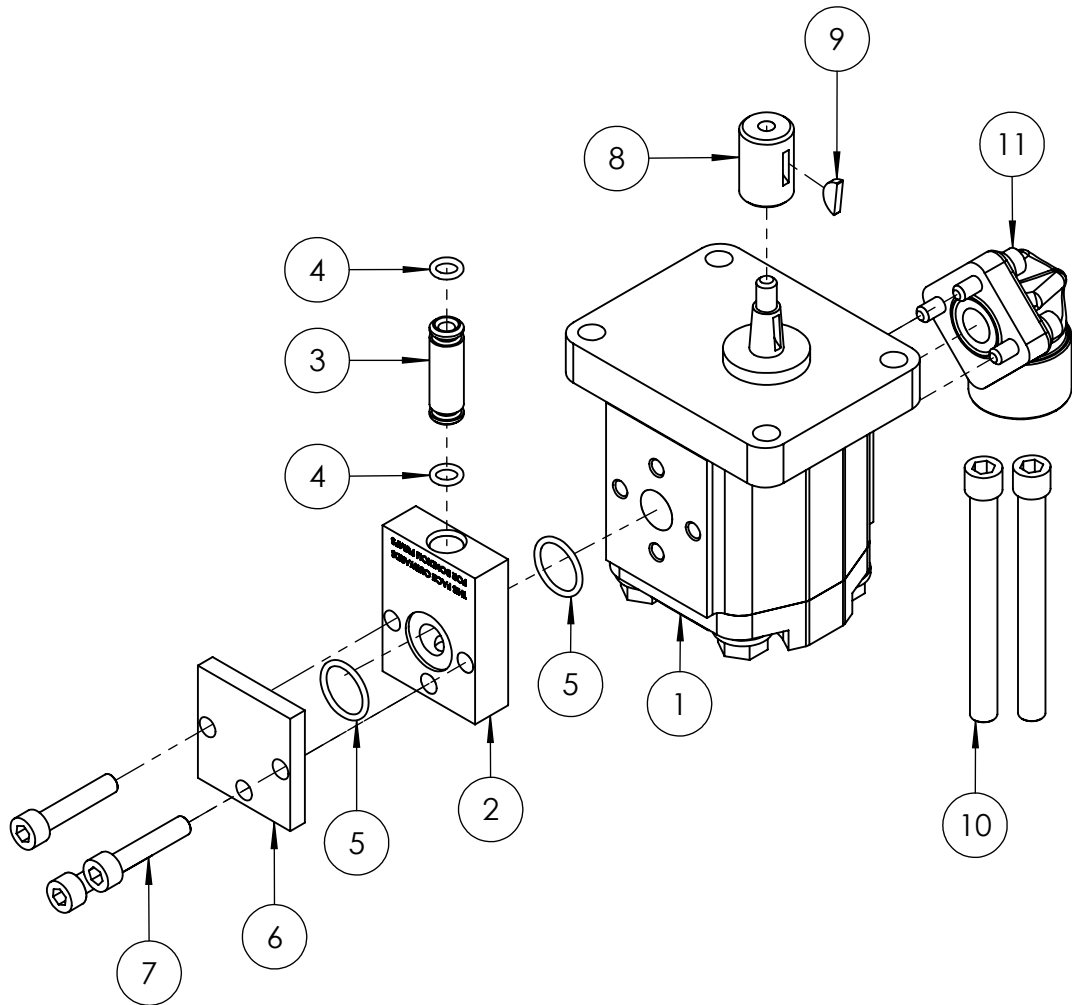

ITEM NO.	PART NUMBER	DESCRIPTION	QTY.	SPARE PARTS	SERVICE PARTS	REVISION
1	GP60	GEAR PUMP	1			1 5939
2	PMC000TM001	TRANSFER PLATE	1			2
3	15510C	CONNECTOR TUBE	1			3
4	SEC010RA001	O-RING - I.D. 6.35 mm, C.S. 1.78 mm, NITRILE 70	2		✓	4
5	SEC019RF002	O-RING - I.D. 15.60, C.S. 1.78mm, NITRILE 90	2		✓	5
6	PMC000XM001	SEALING PLATE	1			6
7	BLC006JD030	M6 x 30 mm HEX SOCKET CAP HEAD SCREW	3			7
8	15507	ADAPTOR	1			8
9	PCC002WC001	KEY TO FIT 200/300 PUMPS	1			9
10	FAS008SP080	M8 X 80 HEX SOCKET REDUCED CAP HEAD SCREW (FULLY THREADED)	2			10
11	FPA013DC001	GEAR PUMP ELBOW (INC WITH GEAR PUMP)	1	x		11

NOTE:

- ALL PARTS ARE AVAILABLE TO BE ORDERED AS SPARE PARTS (UNLESS MARKED WITH X)
- ONLY PARTS MARKED WITH ✓ ARE AVAILABLE AS BOTH SPARE PARTS OR SERVICEABLE PARTS, FROM HEP-SK1 PUMP SERVICE KIT. (REFER TO HEP-SK1: PUMP SERVICE KIT EVD FOR FULL PARTS LIST)
- THE ORIENTATION OF ITEM NO. 2 (PMC000TM001) IS DETERMINED BY THE BRAND OF THE GP60 GEAR PUMP SUPPLIED (REFER TO SHEET 2 FOR FURTHER DETAILS)
- ITEM NO. 10 (FAS008SP080) ARE TO REPLACE TWO SCREWS (BLC008KC080) ON THE TYPE300-24, PRIOR TO FITTING PMA060GZ001 (REFER TO SHEET 3 FOR FURTHER DETAILS)
- INDIVIDUAL ITEMS ARE NOT AVAILABLE AS SPARE PARTS FOR HEP PUMPS WITH SERIAL NUMBERS EARLIER THAN **BR9070**. GP60 GEAR PUMP ASSEMBLY (PMA060GZ001) WILL NEED TO BE ORDERED. INDIVIDUAL ITEMS APART FROM ITEM NO. 11 ARE AVAILABLE AS SPARE PARTS FOR HEP PUMPS WITH SERIAL NUMBERS ABOVE **BR9070**

IMPORTANT

WHEN ORDERING SPARES YOU MUST STATE THE FULL PART NUMBER AND THE PRODUCT SERIAL NUMBER - FROM THE LABEL TO PROTECT YOUR WARRANTY ALWAYS USE GENUINE HI-FORCE PARTS.

ORIENTATION OF TRANSFER PLATE

FOR GALTECH GEAR PUMPS, LOOK FOR "GALTECH" USUALLY FOUND ON THE SIDE OF THE BODY

FOR BONDIOLI GEAR PUMPS, LOOK FOR "BONDIOLI & PAVESI" USUALLY FOUND ON THE BOTTOM OF THE BODY

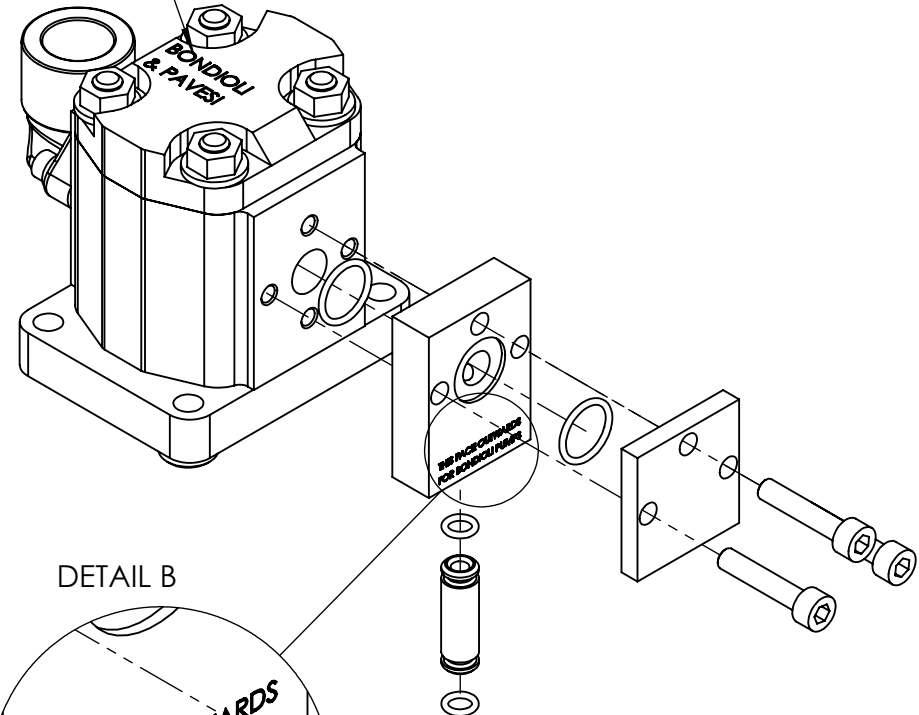
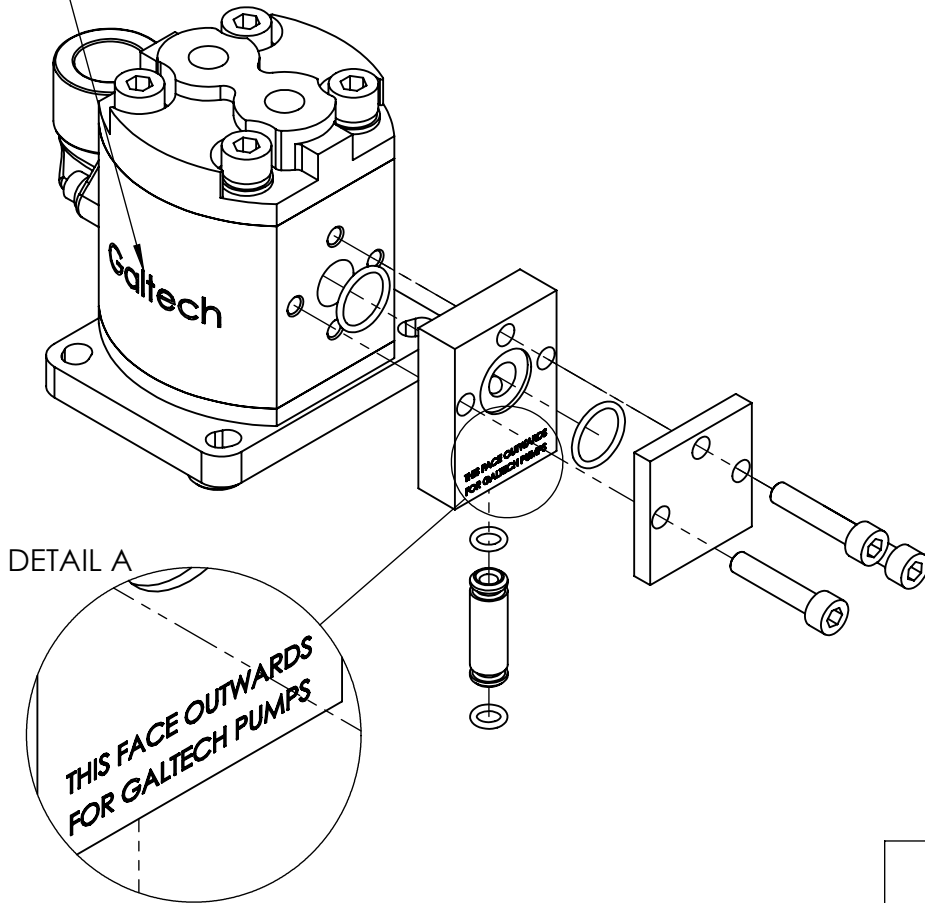

REVISION

1	5939
2	
3	
4	
5	
6	
7	
8	
9	
10	
11	
12	
13	
14	
15	
16	
17	
18	
19	
20	

IMPORTANT
WHEN ORDERING SPARES YOU MUST STATE THE FULL PART NUMBER AND THE PRODUCT SERIAL NUMBER - FROM THE LABEL TO PROTECT YOUR WARRANTY ALWAYS USE GENUINE HI-FORCE PARTS.

REVISION

1	5939
2	
3	
4	
5	
6	
7	
8	
9	
10	
11	
12	
13	
14	
15	
16	
17	
18	
19	
20	

TYPE300-24: BOTTOM VIEW

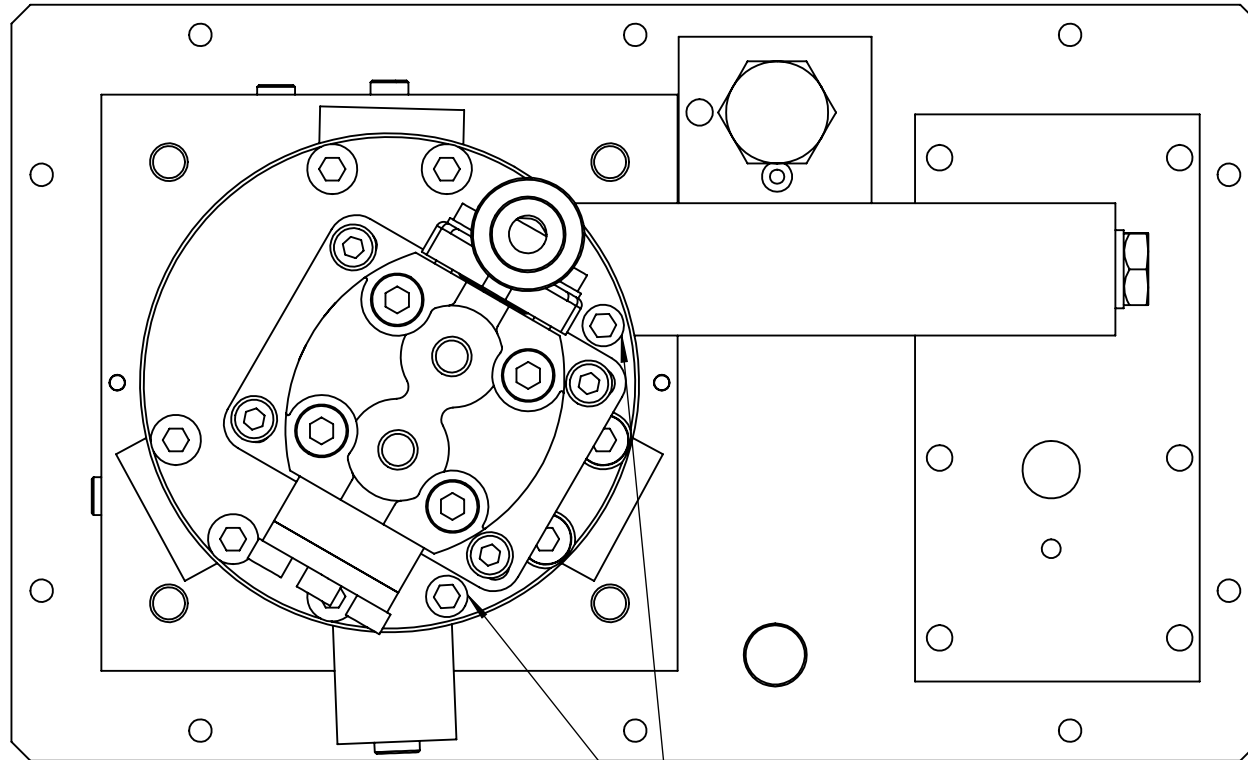

REMOVE THE TWO CURRENT SCREWS FROM THESE TWO POSITIONS AND REPLACE WITH ITEM NO. 10 (FAS008SP080)

IMPORTANT

WHEN ORDERING SPARES YOU MUST STATE THE FULL PART NUMBER AND THE PRODUCT SERIAL NUMBER - FROM THE LABEL TO PROTECT YOUR WARRANTY ALWAYS USE GENUINE HI-FORCE PARTS.

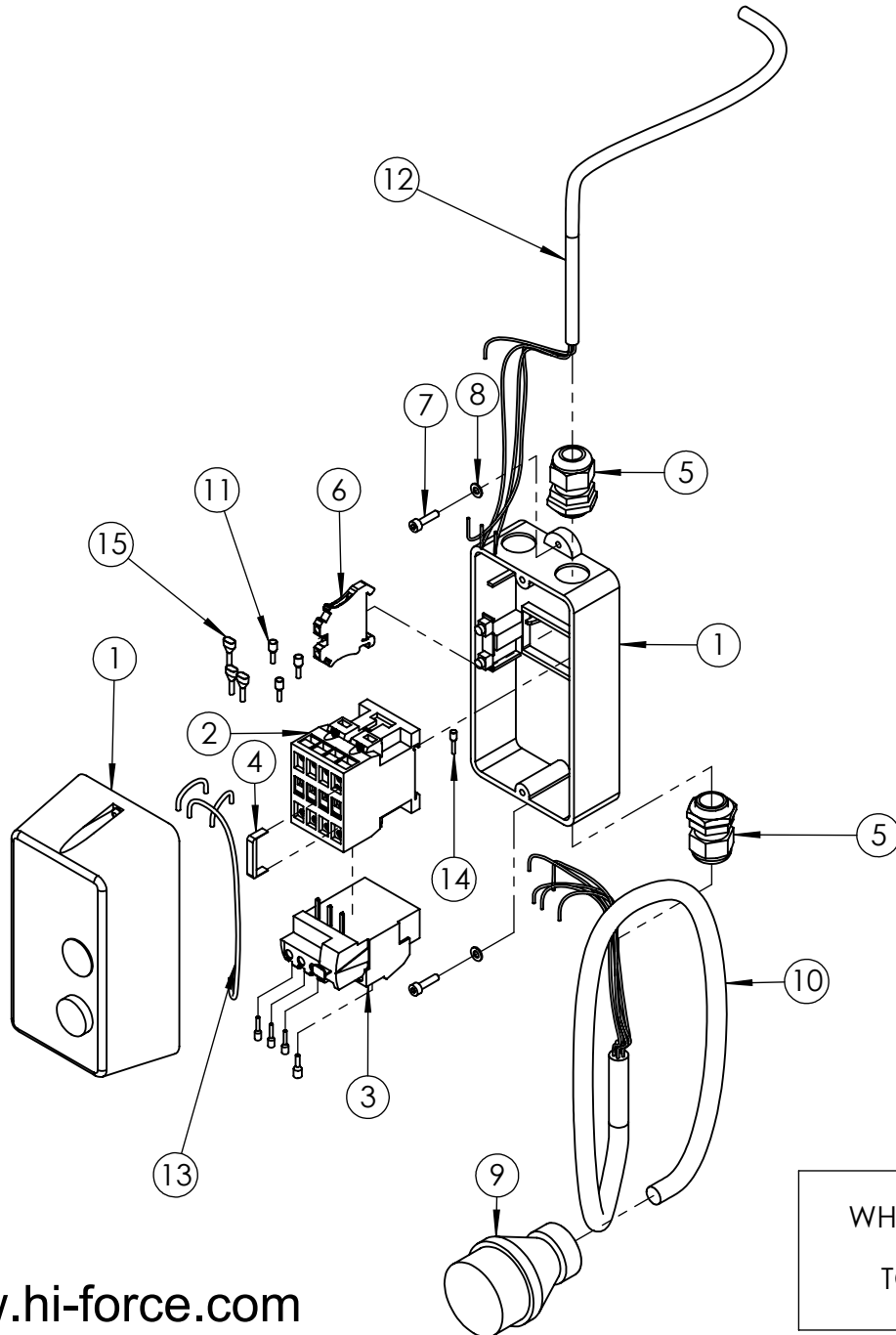

ITEM NO.	PART NUMBER	DESCRIPTION	QTY.	SPARE PARTS	REVISION
					1 5825
1	EMC000EF001	ENCLOSURE WITH PUSH BUTTONS P1MT	1		2
2	EMC415KE001	CONTACTOR 415 V	1		3
3	EMC415RD001	THERMAL OVERLOAD RELAY 4-6 AMPS	1		4
4	EMC110XF001	BRIDGING BAR	1		5
5	NUC020LS002	GLAND 6-12MM	2		6
6	EMC000NZ001	TERMINAL BLOCK	1		7
7	BLC004JD016	M4 x 16 mm HEX SOCKET CAP HEAD SCREW	2		8
8	WAC004YB000	M4 WASHER ST	2		9
9	MCC415EP002	415V, 32A ELECTRICAL PLUG	1		10
10	CEC150EC001	5 CORE CABLE 1.5 mm ² H07RN-F 5G1.5	1		11
11	CEC250SX001	BOOTLACE FERRULE (INSULATED) 2.5mm GREY	4		12
12	CEC150DC000	4 CORE CABLE 1.5 mm ² H07RN-F 4G1.5	1		13
13	CEC250AC000	SINGLE CORE TRI-RATED CABLE 2.5mm ² BLACK H05V2-K / H07V2-K	1		14
14	CEC150SX001	BOOTLACE FERRULE (INSULATED) 1.5mm	4		15
15	CEC250SX002	TWIN BOOTLACE FERRULE 2.5 mm ²	3		16
					17
					18
					19
					20

NOTE:

- ALL PARTS ARE AVAILABLE TO BE ORDERED AS SPARE PARTS (UNLESS MARKED WITH X).

IMPORTANT

WHEN ORDERING SPARES YOU MUST STATE THE FULL PART NUMBER AND THE PRODUCT SERIAL NUMBER - FROM THE LABEL TO PROTECT YOUR WARRANTY ALWAYS USE GENUINE HI-FORCE PARTS.

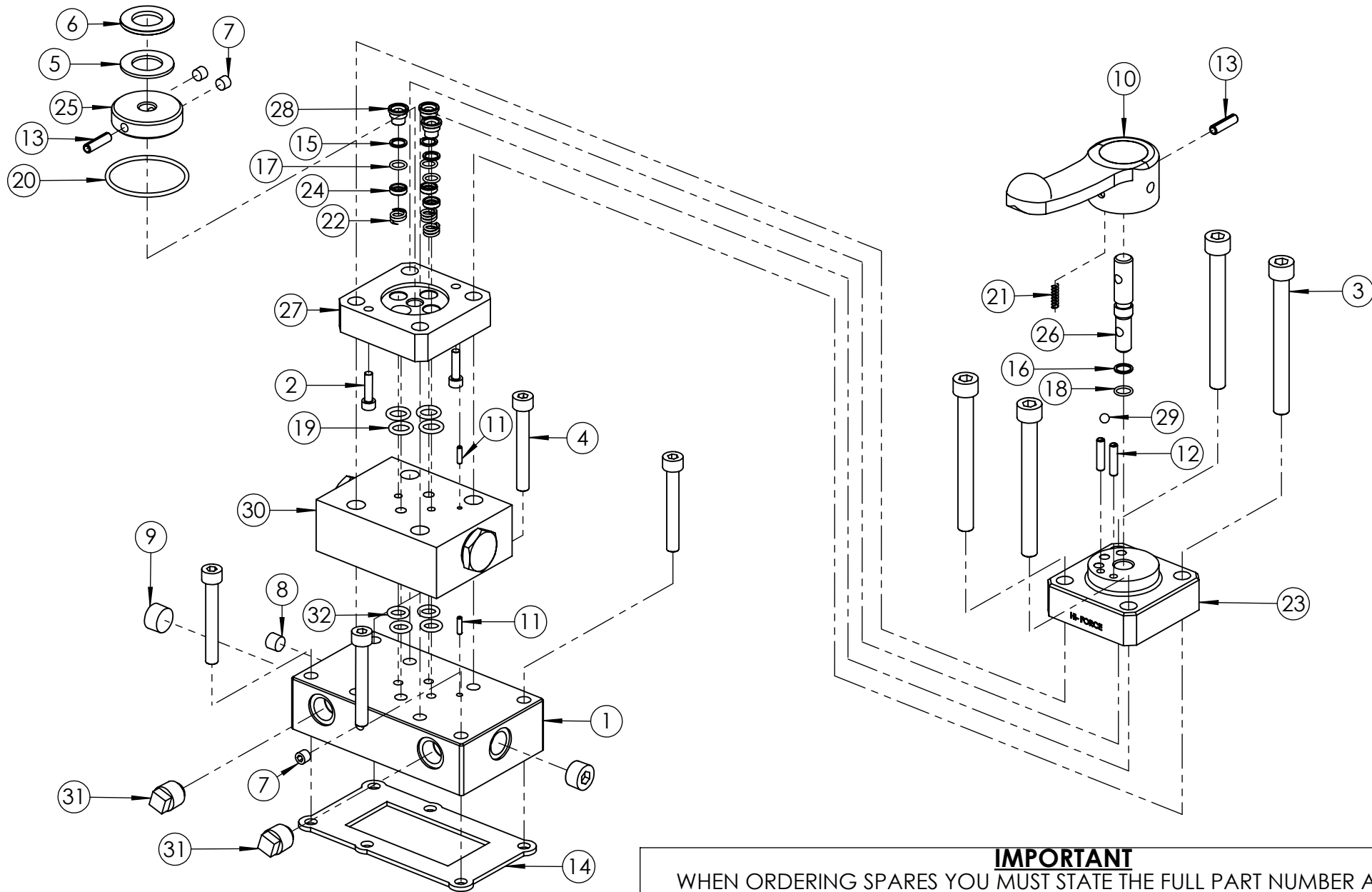

REVISION

1 5717

2

3

4

5

6

7

8

9

10

11

12

13

14

15

16

17

18

19

20

IMPORTANT

WHEN ORDERING SPARES YOU MUST STATE THE FULL PART NUMBER AND THE
PRODUCT SERIAL NUMBER - FROM THE LABEL
TO PROTECT YOUR WARRANTY ALWAYS USE GENUINE HI-FORCE PARTS.

ITEM NO.	PART NUMBER	DESCRIPTION	QTY.	SPARE PARTS	SERVICE PARTS
1	VFC010BF007	VALVE MOUNTING BLOCK	1		
2	BLC005HU020	M5 x 20 mm HEX SOCKET CAP HEAD SCREW	2		
3	BLC010LC100	M10 x 100 mm HEX SOCKET CAP HEAD SCREW	4		
4	BLC008KC060	M8 x 60 mm HEX SOCKET CAP HEAD SCREW	4		
5	BSC035NA001	NEEDLE BEARING	1		
6	BSC035NA002	HOUSING WASHER	1		
7	FPC002PN001	1/16" x 7/8" NPT SOCKET PLUG	3		
8	FPC003PN001	1/8" x 3/4" NPT TAPER DRY SEAL PRESS PLUG	1		
9	FPC010PN002	3/8" X 7/8" NPT SOCKET PLUG	2		
10	HLC012LP002	HANDLE	1		
11	PCC003RB006	Ø3 x 12 mm SELLOCK PIN	2		
12	PCC005RD002	Ø5 x 22 mm SPIROL PIN	2		
13	PCC006RD001	Ø6 X 22 mm SPIROL PIN	2		
14	SEC003KT001	VALVE GASKET	1		✓
15	SEC011BA001	BACK UP RING	3		✓
16	SEC012BA002	BACK UP RING	1		✓
17	SEC011RA001	O-RING - I.D. 8.10 mm, C.S. 1.6 mm, NITRILE 90	3		✓
18	SEC012RA003	O-RING - I.D. 9 mm, C.S. 1.50 mm, NITRILE 70	1		✓
19	SEC016RA002	O-RING - I.D. 10.77 mm, C.S. 2.62 mm, NITRILE 70	4		✓
20	SEC049RF001	O-RING - I.D. 48.90 mm, C.S. 2.62 mm, NITRILE 90	1		✓
21	SPC005KA001	SPRING	1		
22	SPC010CA001	SPRING	3		
23	VFC000BD003	VALVE BODY	1		
24	VFC000SC001	SHEAR SEAL COLLAR	3		
25	VFC000SQ002	VALVE ROTOR	1		

ITEM NO.	PART NUMBER	DESCRIPTION	QTY.	SPARE PARTS	SERVICE PARTS	REVISION
26	VFC000SR002	SPINDLE	1			1 5717
27	VFC000ST001	SHEAR SEAL PLATE	1			2
28	VFC000SU001	SHEAR SEAL	3			3
29	BAC006SN000	Ø6 mm STEEL BALL	1			4
30	V-8245	DUAL CHECK VALVE	1			5
31	BPC010SP004	3/8 NPT PLASTIC BLANKING PLUG (RED)	2			6
32	SEC014RA001	O-RING - I.D. 9.19mm, C.S. 2.62mm, NITRILE 90	4		✓	7
						8
						9
						10
						11
						12
						13
						14
						15
						16
						17
						18
						19
						20

NOTE:

- ALL PARTS ARE AVAILABLE TO BE ORDERED AS SPARE PARTS (UNLESS MARKED WITH **X**).

- ONLY PARTS MARKED WITH **✓** ARE AVAILABLE AS BOTH SPARE PARTS OR SERVICEABLE PARTS, FROM **DCV-M1 : SERVICE KIT (3 & WAY MANUAL VALVES)**. (REFER TO **DCV-M1** EVD FOR FULL PARTS LIST)

- IF ITEM NO. 30 IS ORDERED AS A SPARE PART, THIS ALREADY COMES WITH ITEM NO. 32. THEREFORE THESE ARE NOT REQUIRED TO BE ORDERED SEPERATELY.

IMPORTANT

WHEN ORDERING SPARES YOU MUST STATE THE FULL PART NUMBER AND THE PRODUCT SERIAL NUMBER - FROM THE LABEL TO PROTECT YOUR WARRANTY ALWAYS USE GENUINE HI-FORCE PARTS.

ITEM NO.	PART NUMBER	DESCRIPTION	QTY.	REVISION
1	15482	TANK GASKET	1	1 5717
2	SEC010RA001	O-RING - I.D. 6.35 mm, C.S. 1.78 mm, NITRILE 70	2	2 5939
3	SEC014RF001	O-RING - I.D. 10.82 mm, C.S. 1.78 mm, NITRILE 90	10	3
4	SEC013RA001	O-RING - I.D. 9.25mm, C.S. 1.78mm, NITRILE 90	2	4
5	SEC019RF002	O-RING - I.D. 15.60, C.S. 1.78mm, NITRILE 90	2	5
6	SEC013BA001	BACK-UP RING - PTFE, SOLID SPLIT	2	6
7	SEC001KT003	GASKET	1	7
				8
				9
				10
				11
				12
				13
				14
				15
				16
				17
				18
				19
				20

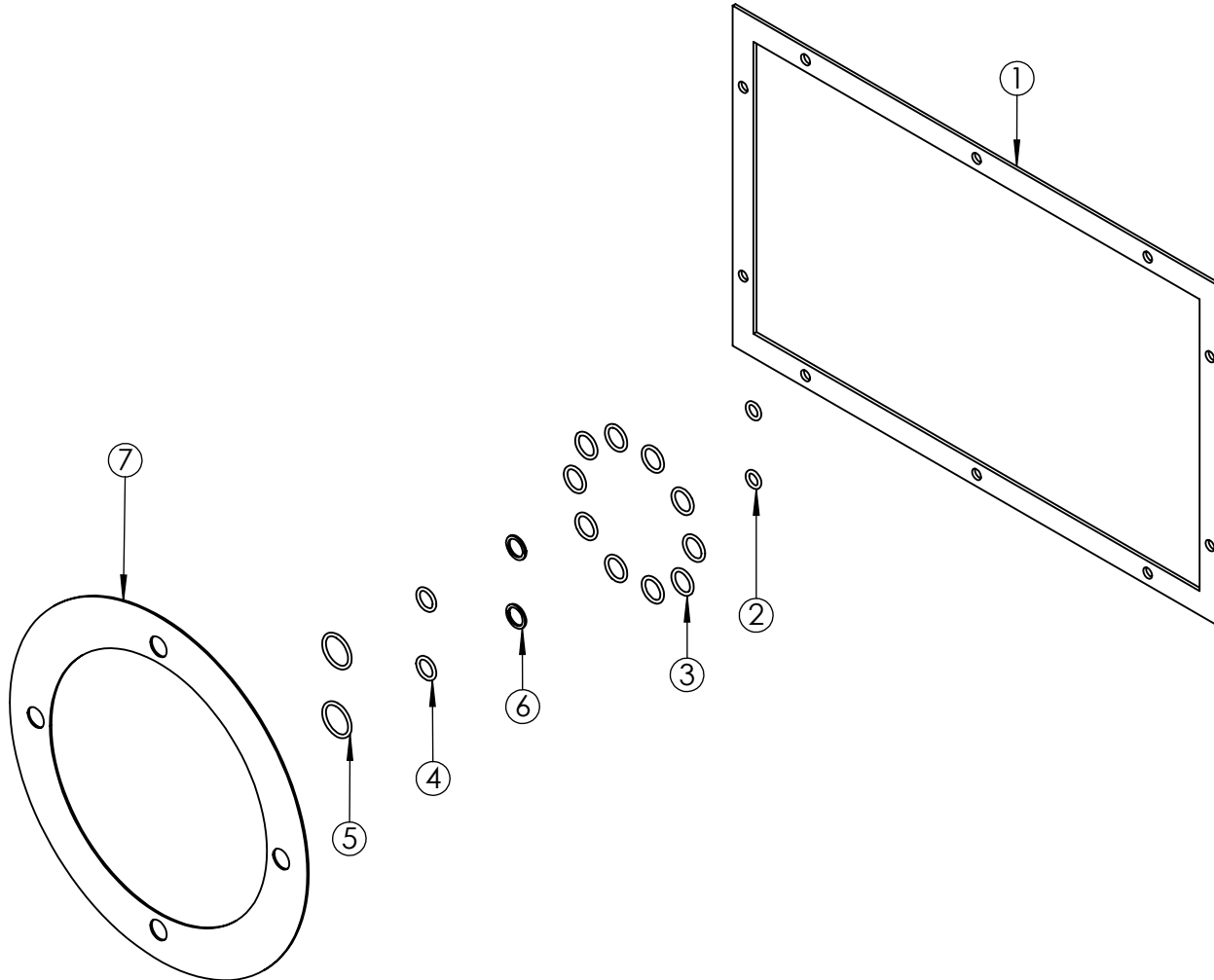

IMPORTANT

WHEN ORDERING SPARES YOU MUST STATE THE FULL PART NUMBER AND THE PRODUCT SERIAL NUMBER - FROM THE LABEL TO PROTECT YOUR WARRANTY ALWAYS USE GENUINE HI-FORCE PARTS.

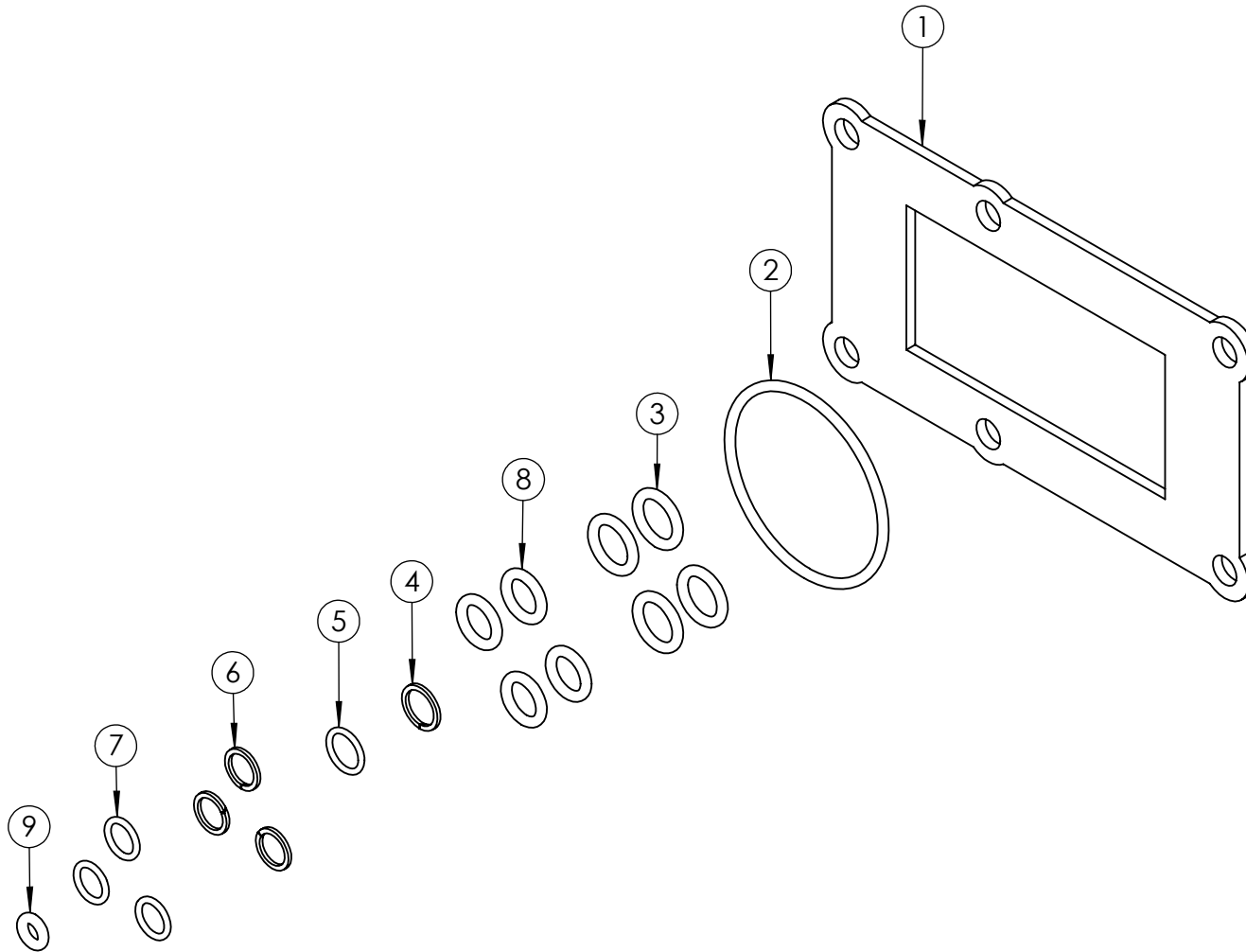

ITEM NO.	PART NUMBER	DESCRIPTION	QTY.	REVISION
1	SEC003KT001	VALVE GASKET	1	1 5717
2	SEC049RF001	O-RING - I.D. 48.90 mm, C.S. 2.62 mm, NITRILE 90	1	2
3	SEC016RA002	O-RING - I.D. 10.77 mm, C.S. 2.62 mm, NITRILE 70	4	3
4	SEC012BA002	BACK UP RING	1	4
5	SEC012RA003	O-RING - I.D. 9 mm, C.S. 1.50 mm, NITRILE 70	1	5
6	SEC011BA001	BACK UP RING	3	6
7	SEC011RA001	O-RING - I.D. 8.10 mm, C.S. 1.6 mm, NITRILE 90	3	7
8	SEC014RA001	O-RING - I.D. 9.19mm, C.S. 2.62mm, NITRILE 90	4	8
9	SEC010RF002	O-RING - I.D. 4.42 mm, C.S. 2.62 mm, NITRILE 70	1	9
				10
				11
				12
				13
				14
				15
				16
				17
				18
				19
				20

IMPORTANT

WHEN ORDERING SPARES YOU MUST STATE THE FULL PART NUMBER AND THE PRODUCT SERIAL NUMBER - FROM THE LABEL TO PROTECT YOUR WARRANTY ALWAYS USE GENUINE HI-FORCE PARTS.